

# STRUCTURAL

# MANUAL

UNIVERSAL & CLICK SYSTEM

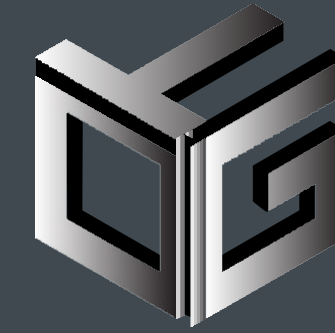

GTO  
ALUMINUM  
MANUFACTURING



# ENDLESS POSSIBILITIES

*Imagine Legos made of aluminum - that's how easy it is to assemble!*

From high rise buildings to fences or interior and exterior walls, its like playing Lego.

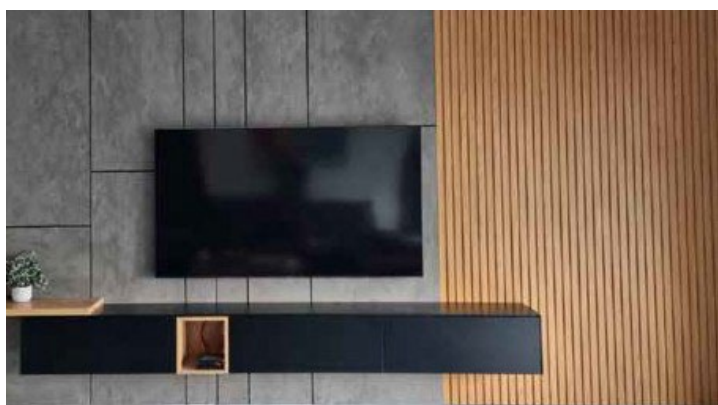
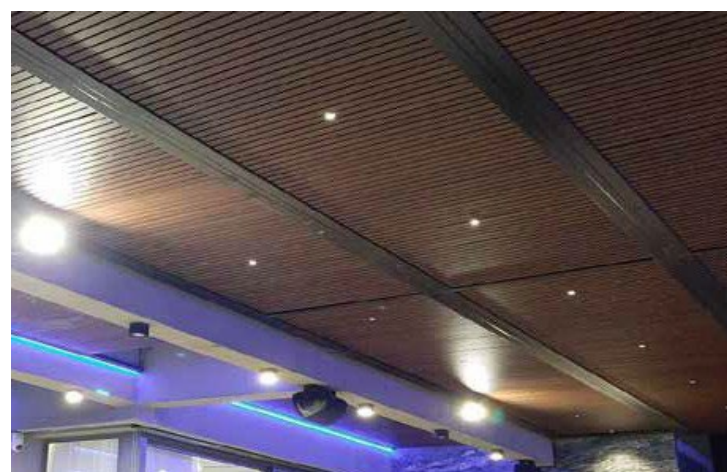

# INSTRUCTION MANUAL

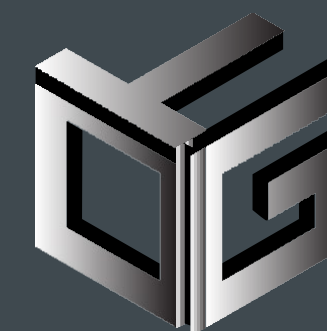

GTO  
ALUMINUM  
MANUFACTURING

CLICK SYSTEM

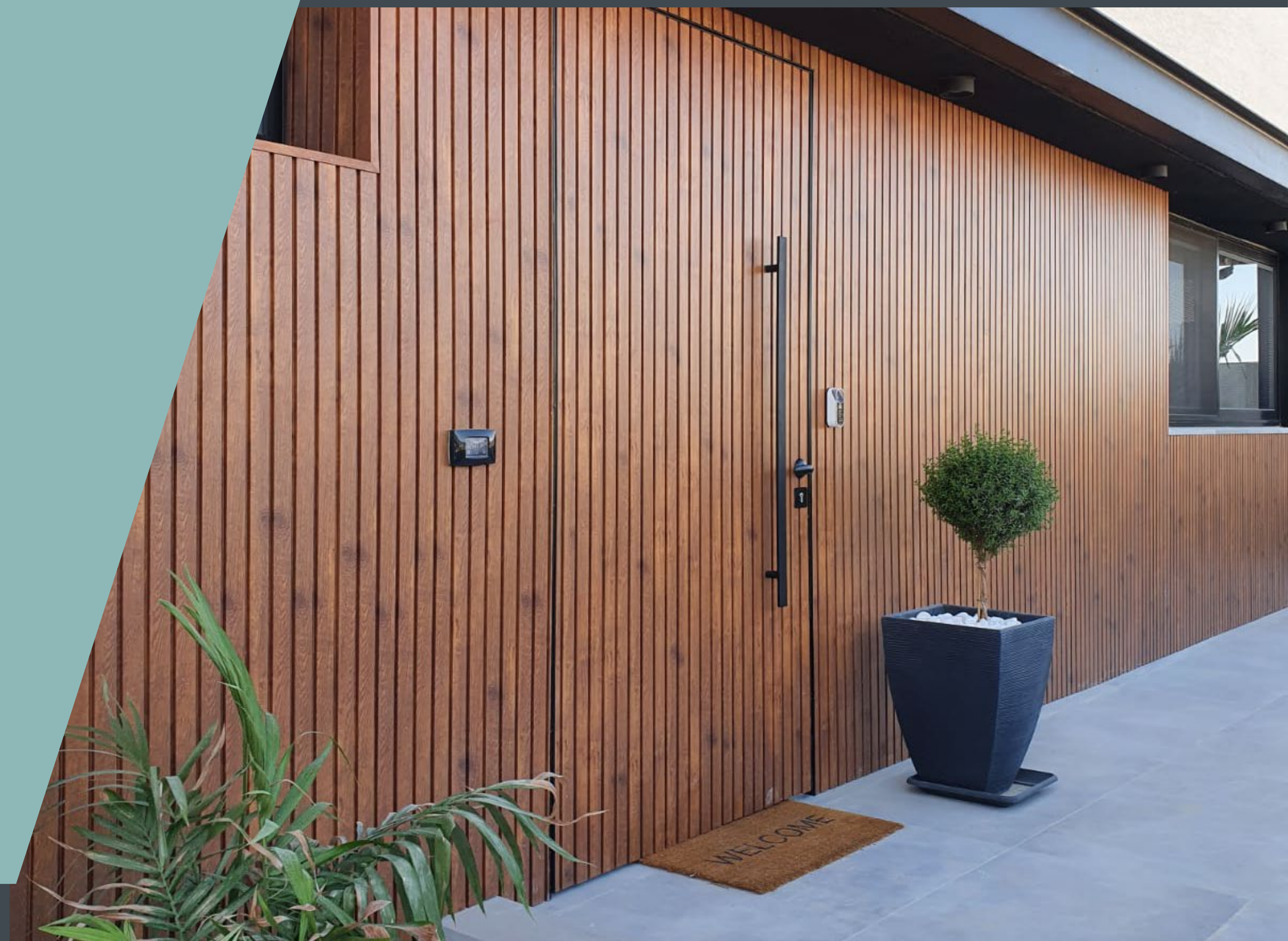

# STEP 1

## Find and Mark Wall Studs

**1.** Use a “stud finder” to find the studs in the wall. If you don’t have one, remember the following.

- ❑ Studs are spaced either 16 or 24 inches on center (measured from center to center) along the wall and run between the floor and ceiling.
- ❑ Most electrical boxes for switches or outlets are attached to a stud on one side.
- ❑ There are studs on either side of a window.
- ❑ Most trim (crown molding, baseboard, and shoe molding) is nailed on the stud. The actual lumber dimensions of 2×4 studs are 1½ inches by 3½ inches.

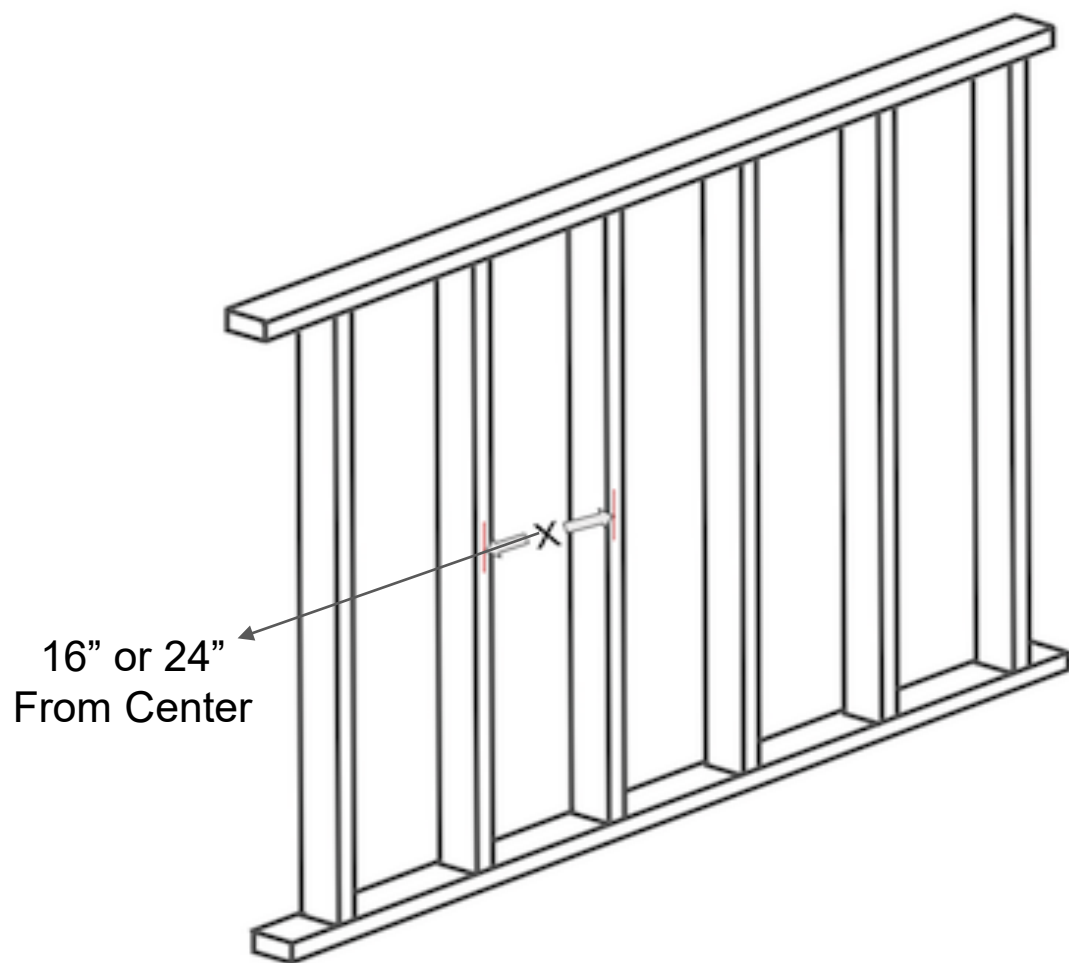

Find and Mark 2 spots on the stud (High and Low).

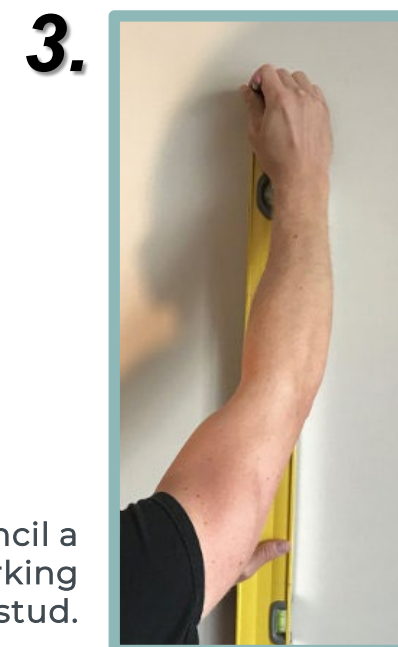

Use a Level to pencil a line on the wall marking the stud.

### Recommended Tools & Accessories

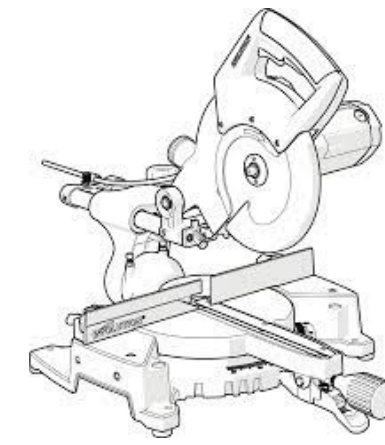

Compound Miter Saw

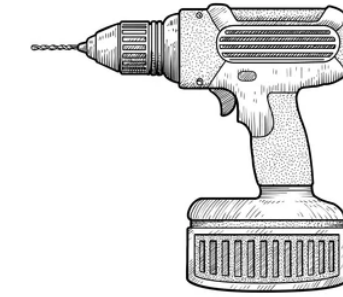

Drill Machine

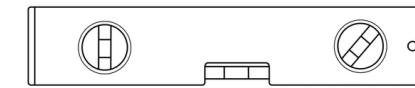

Building Level

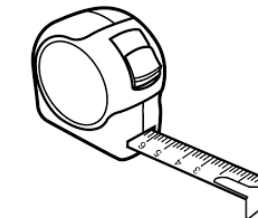

Measuring Tape



Silicon Gun

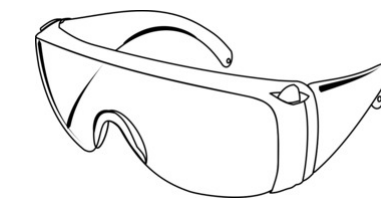

Safety Goggles



Construction Pencil



Stud Finder

➤ If not using the “U Profile”, it is recommended to paint the back wall in black for better visual and aesthetics.

# STEP 2

## Level The Rails On The Wall

1.

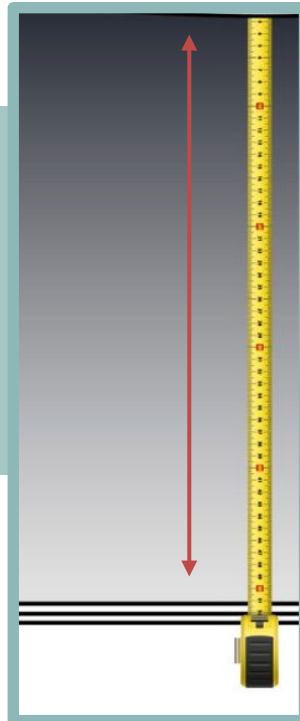

- Measure wall Height or Width of the wall, (depending if installing horizontal or vertical")
- CUT the rails to measurement size.

2.

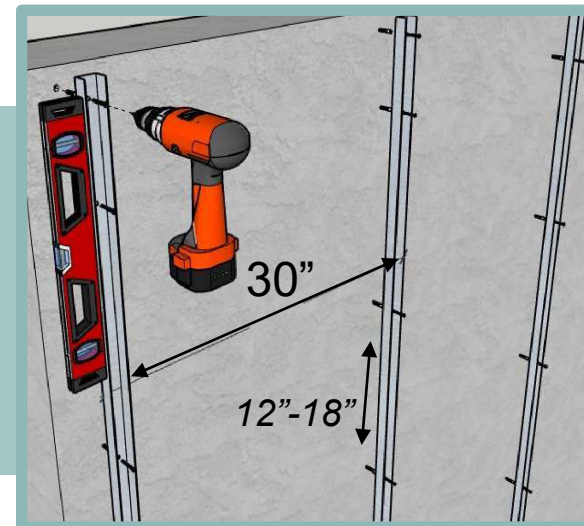

- While using a Level, Drill holes with the drill bit (smaller diameter than the screws you are using.) into the "Rail" / "Alex System". Then, drill screws into the holes connecting rails to the wall surface.
- Make sure to drill the wholes in *12"-18" spacing*.
- Make sure to have 30" spacing between the rails.

3.

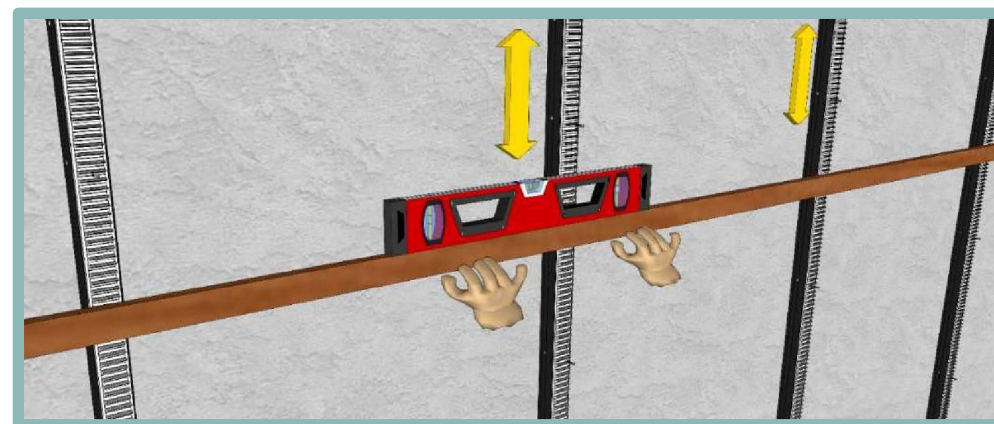

After you have fixed the rails to the wall run a "click profile" through the rails using a level, to act as a gauge.

4.

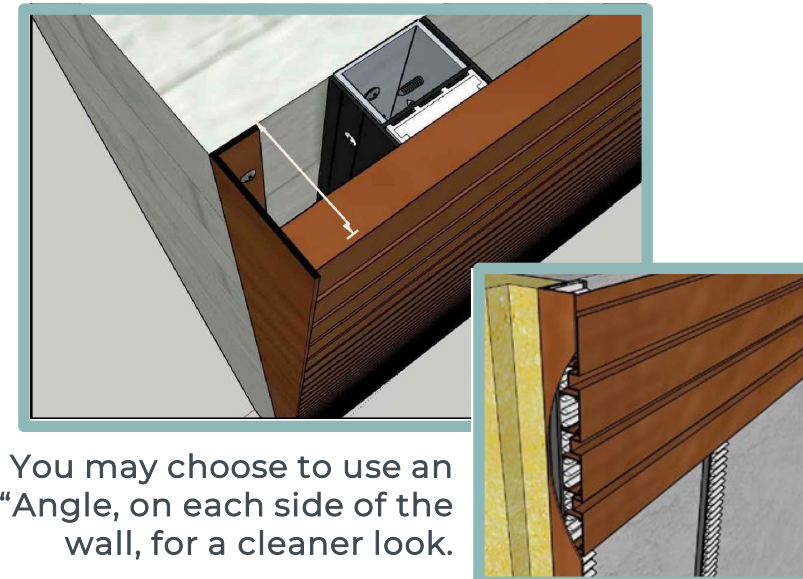

You may choose to use an "Angle, on each side of the wall, for a cleaner look.

### Needed For This Step



RAILS



30/30 ANGLES

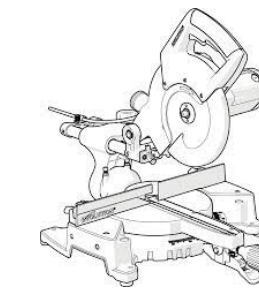

Compound Miter Saw

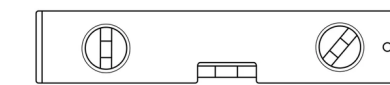

Building Level

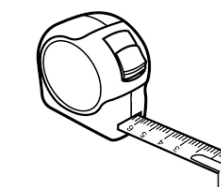

Measuring Tape

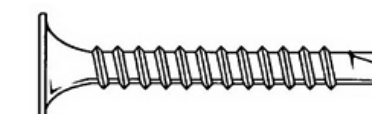

2"-3" #8 Drill Flat Head Screws

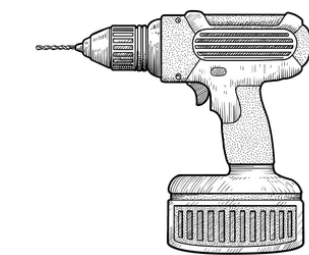

Drill Machine



Construction Pencil

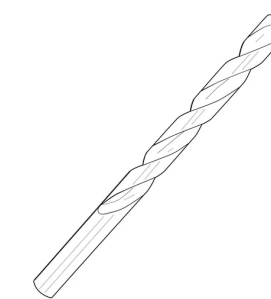

Drill Bit  
(smaller diameter than the screw used)

# STEP 3

## Clicking The Profiles + Finishes

1.

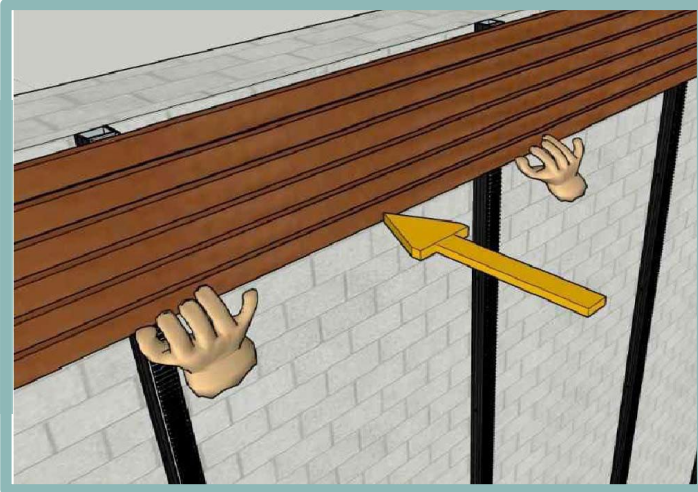

- Begin to "click" each end of the profile directly onto the rails. Making sure with each "click" the profiles are leveled.
- Profiles need to be clicked at least 1 " rail teeth" apart.

2.



- Apply silicon on the Rail Teeth and place the "U profile" on top of the silicon.
- Apply and press, the "U Profile" in the gaps between the click profiles for a luxurious and clean look.

### Needed For This Step

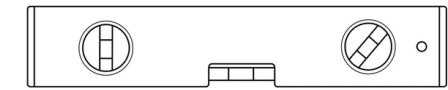

Building Level

CLICK PROFILES, Cut to Measurements.



"U PROFILE"  
(If applicable)



Silicon Gun



# INSTRUCTION MANUAL

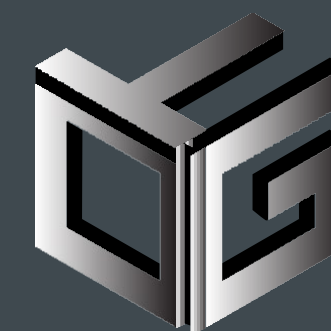

GTO  
ALUMINUM  
MANUFACTURING

UNIVERSAL-SYSTEMS

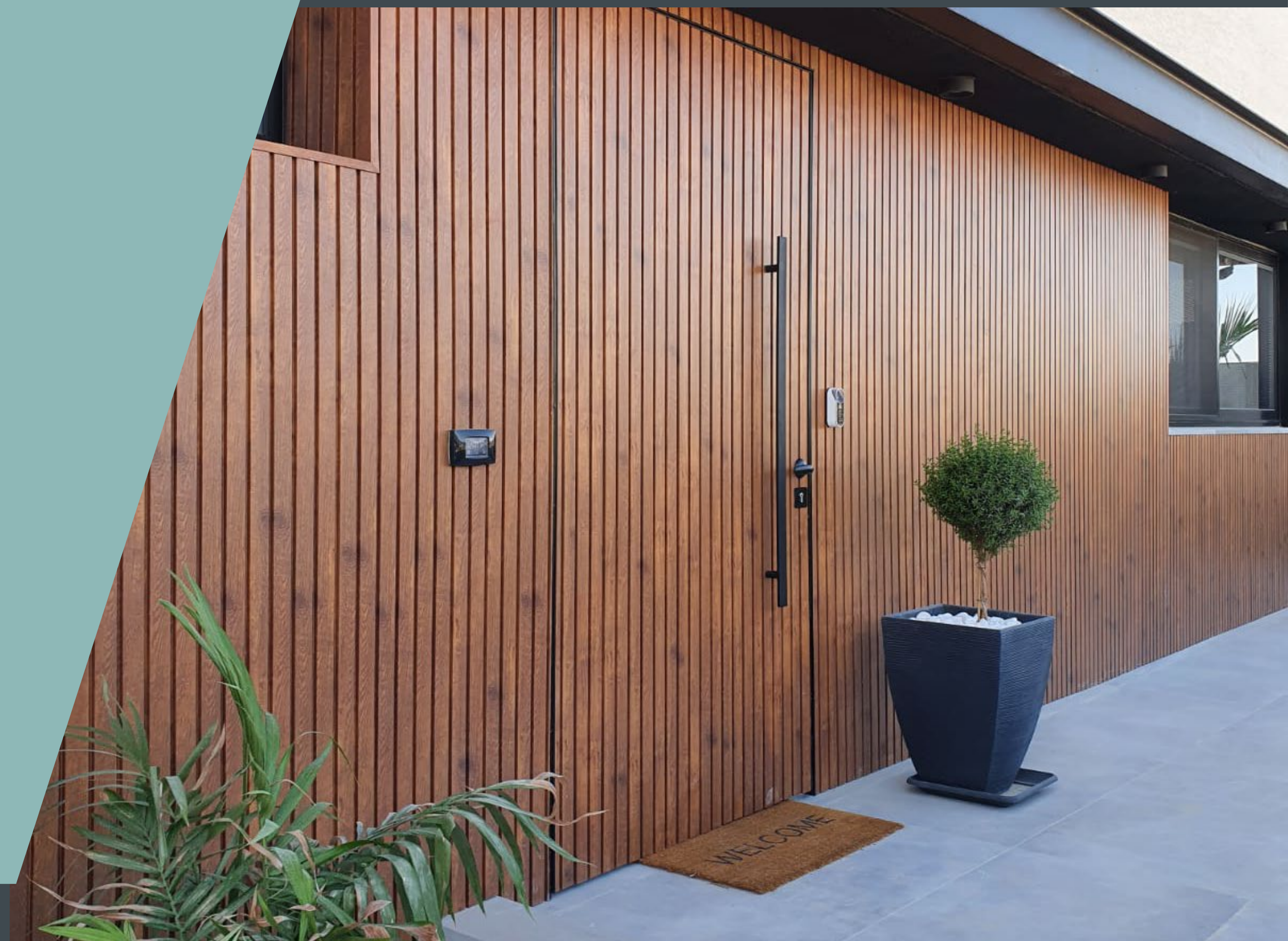

# STEP 1

## Find and Mark Wall Studs

**1.** Use a “stud finder” to find the studs in the wall. If you don’t have one, remember the following.

- ❑ Studs are spaced either 16 or 24 inches on center (measured from center to center) along the wall and run between the floor and ceiling.
- ❑ Most electrical boxes for switches or outlets are attached to a stud on one side.
- ❑ There are studs on either side of a window.
- ❑ Most trim (crown molding, baseboard, and shoe molding) is nailed on the stud. The actual lumber dimensions of 2×4 studs are 1½ inches by 3½ inches.

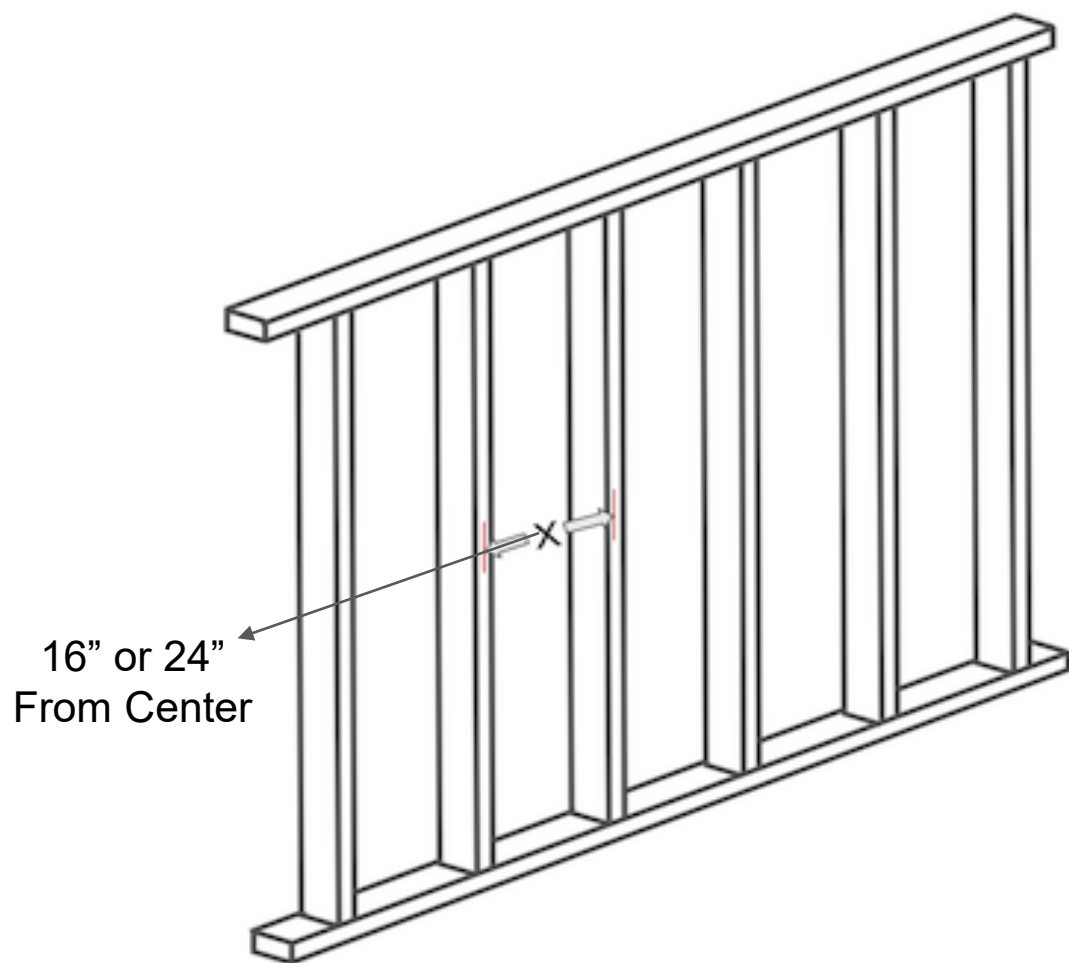

Find and Mark 2 spots on the stud (High and Low).

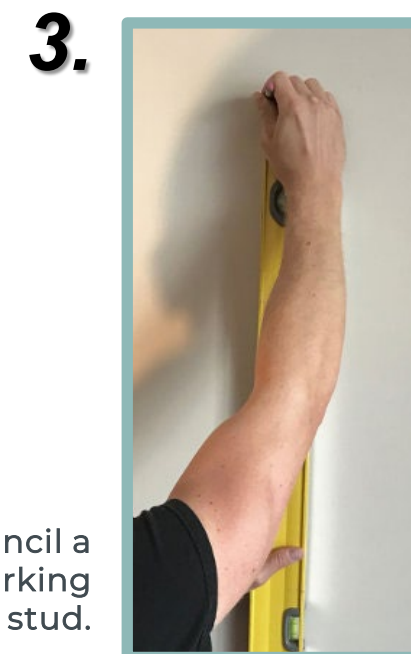

Use a Level to pencil a line on the wall marking the stud.

## Recommended Tools & Accessories

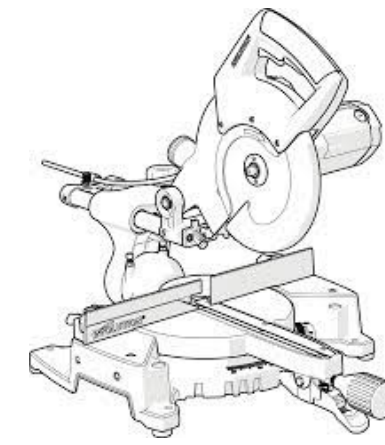

Compound Miter Saw

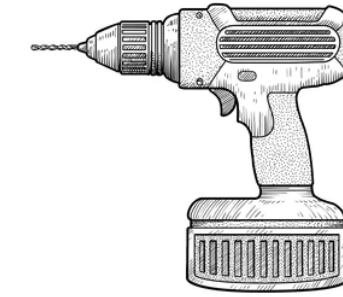

Drill Machine

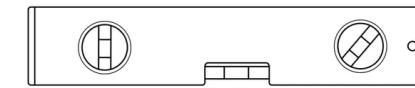

Building Level

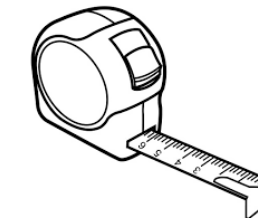

Measuring Tape



Silicon Gun

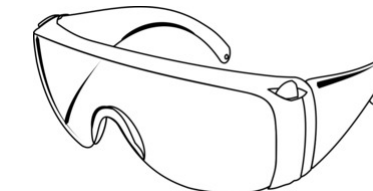

Safety Goggles



Construction Pencil



Stud Finder

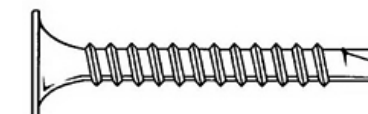

2"-3" #8 Drill Flat Head Screws

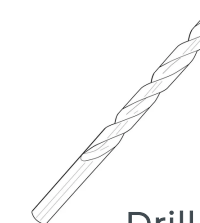

Drill Bit  
(smaller diameter than the screw used)



# STEP 2

Level The Rails On The Wall and install the first profile.

1.

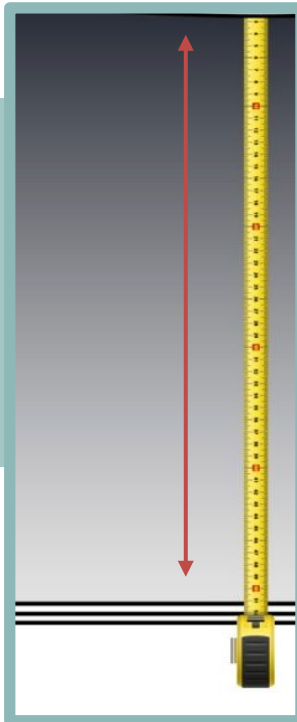

USING THE "U 37" IS RECOMMENDED FOR EXTERIOR WALLS, FOR INTERIOR WORK YOU CAN INSTALL THE PROFILES DIRECTLY INTO THE WALL STUDS.

- Measure wall Height or Width of the wall, (depending if installing horizontal or vertical")
- CUT the "U"37 (or any other external stud) to measurement size.

2.

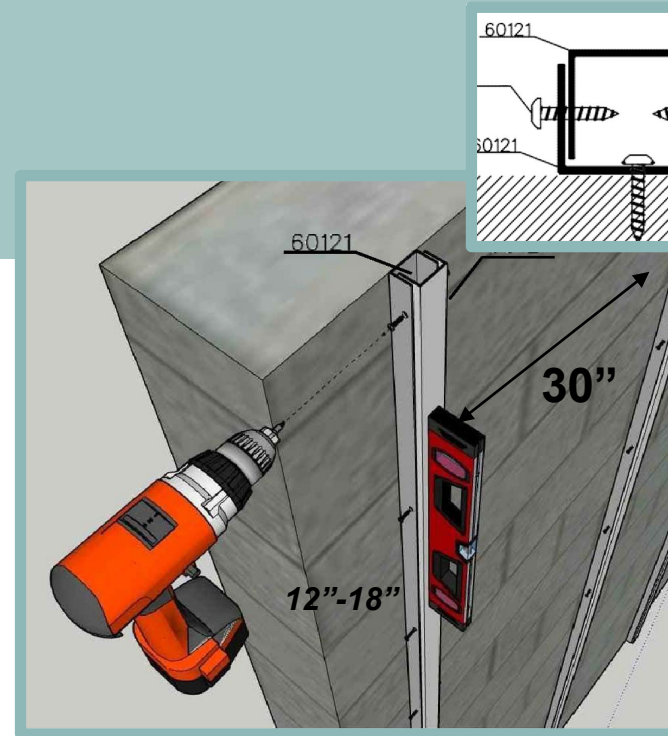

- While using a Level, Drill holes with the drill bit (smaller diameter than the screws you are using.) into the "U 37" (or other external stud).
- Make sure to drill the wholes in **12"-18" spacing.**
- Make sure to have 30" spacing between the External studs .

3.

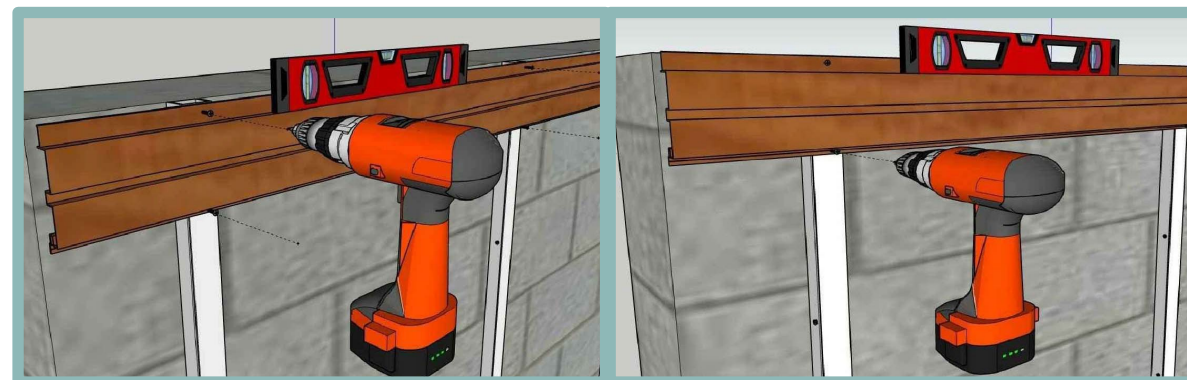

- Cut Profiles to the desired measurement.
- After you have fixed the External studs to the wall, install the Top profile to the studs, while using a level, to act as a gauge, (recommended to use drill head screws.)

## Needed For This Step

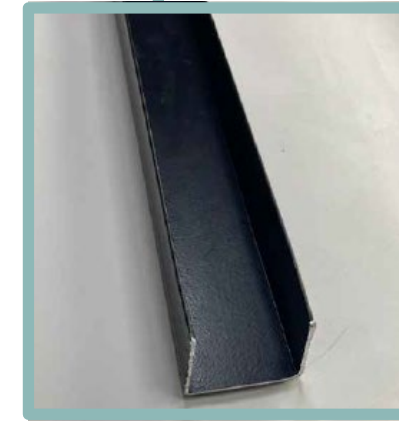

"U 37",  
Or any other  
external stud



UNIVERSAL PROFILES

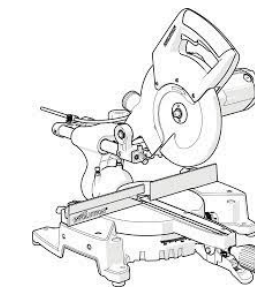

Compound Miter Saw



Building Level

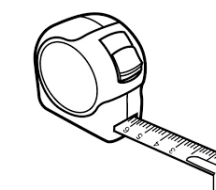

Measuring Tape

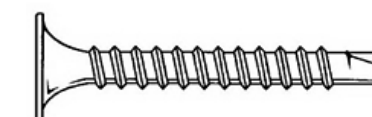

2"-3" #8 Drill Flat Head Screws

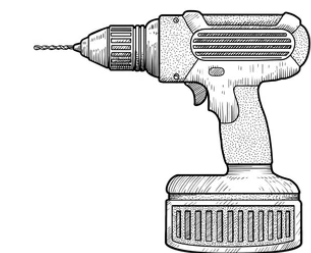

Drill Machine



Construction Pencil

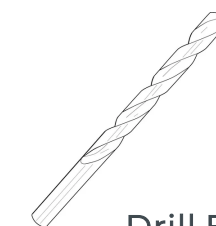

Drill Bit  
(smaller diameter than the  
screw used)

# STEP 3

## Sliding and Securing The Profiles + Finishes

1.

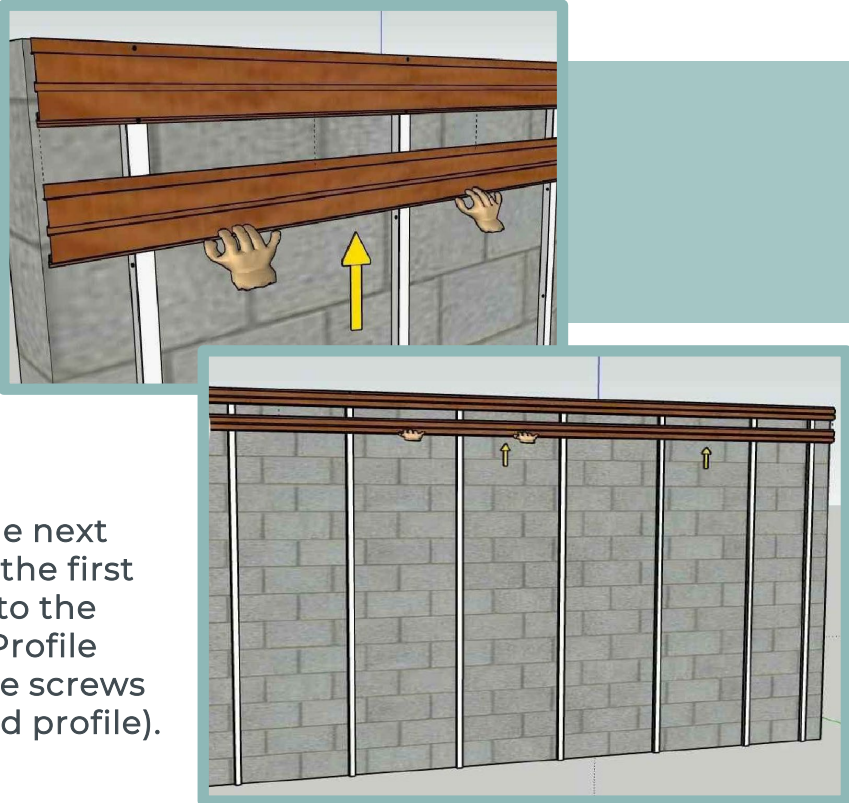

Slide in the next profile into the first profile into the secured Profile (covering the screws of the covered profile).

2.

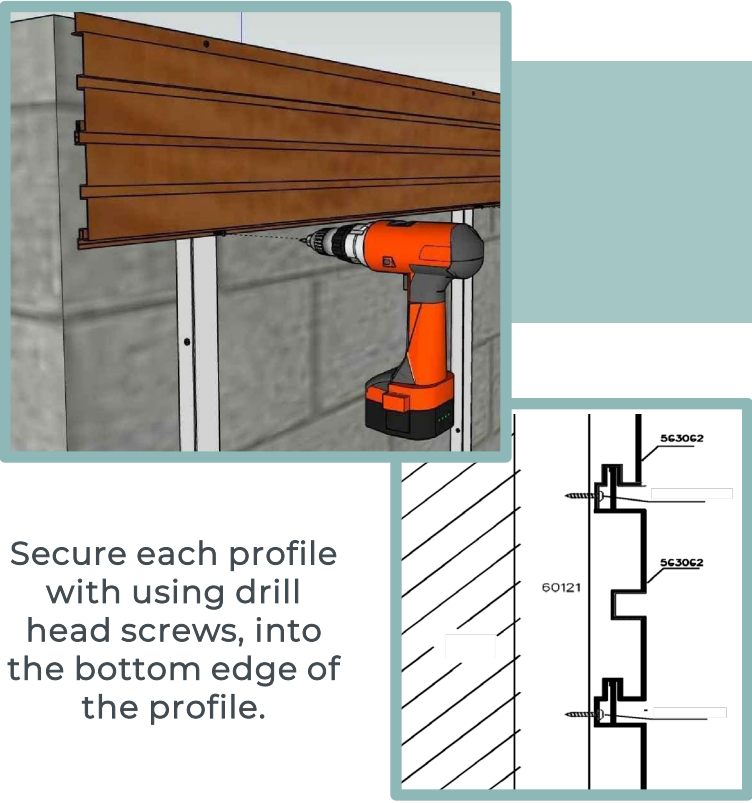

Secure each profile with using drill head screws, into the bottom edge of the profile.

### Needed For This Step



Silicon Gun

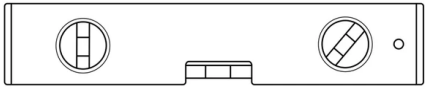

Building Level

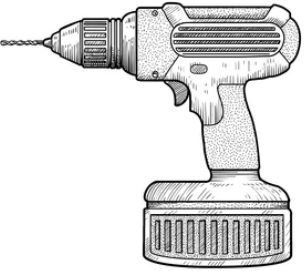

Drill Machine

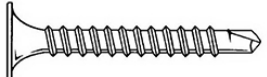

2"-3" #8 Drill Flat Head Screws

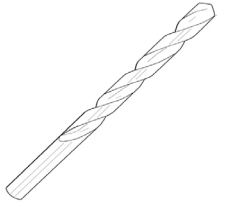

Drill Bit (smaller diameter than the screw used)

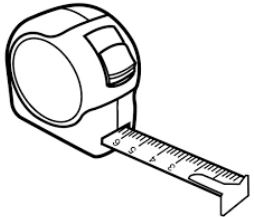

Measuring Tape

Cover edges with an angle, using screws or silicon.

3.

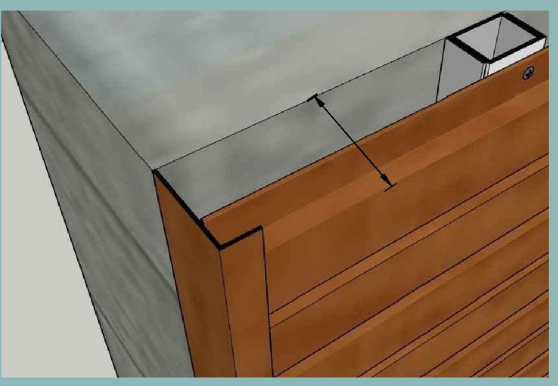

OR

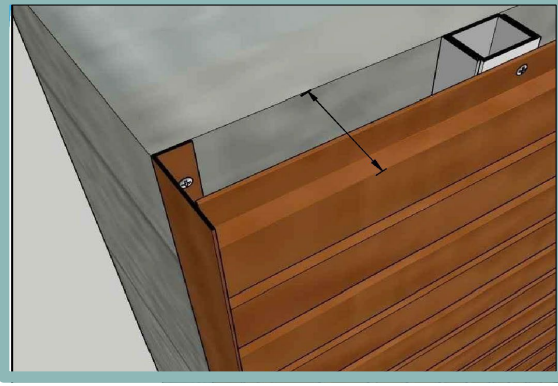

OR

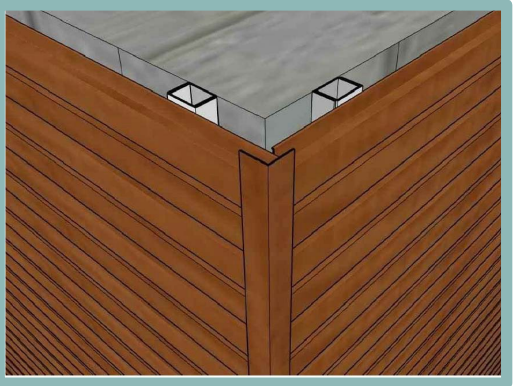

OR

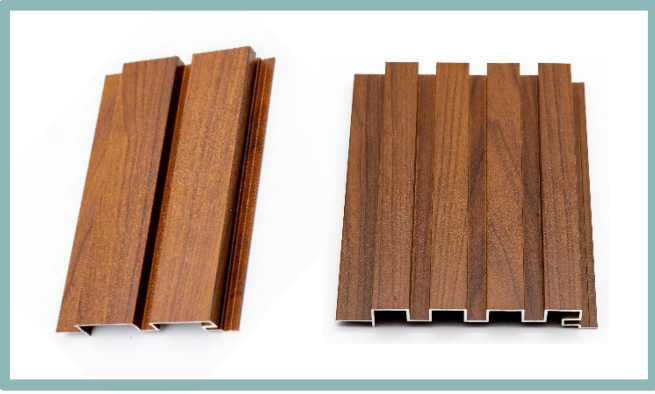
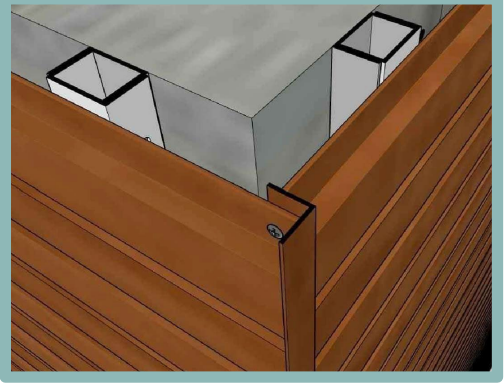

UNIVERSAL PROFILES

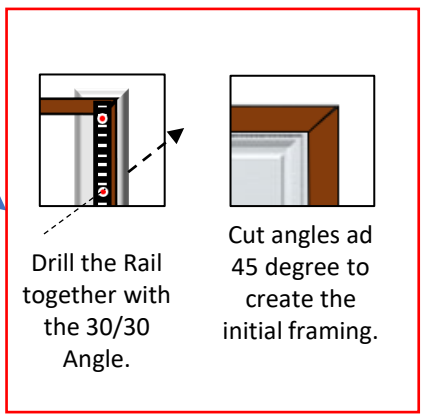
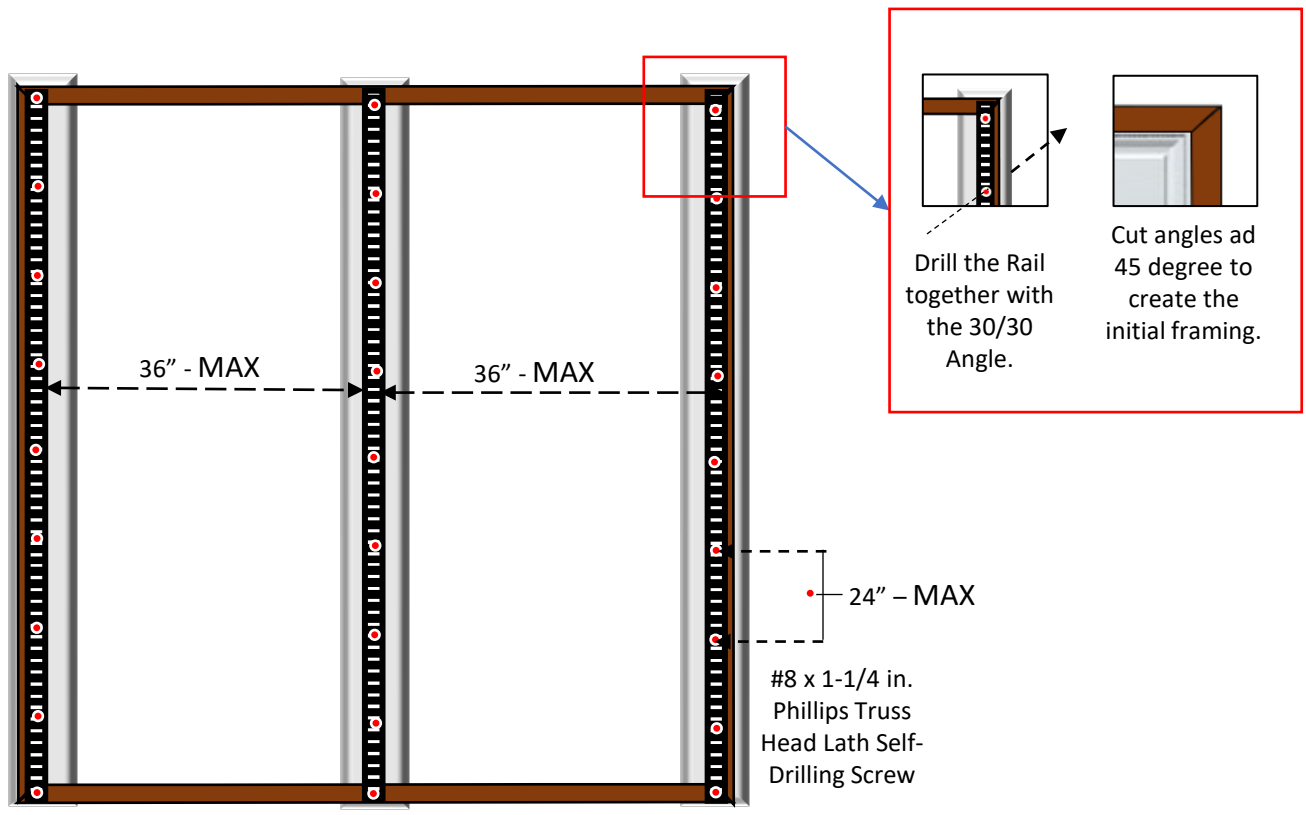

# STRUCTURAL BEAMS INSTALLATION

#8 x 1-1/4 in. Phillips Truss Head Lath Self-Drilling Screw

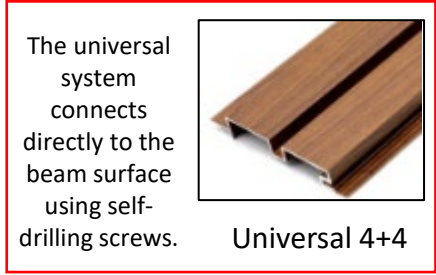
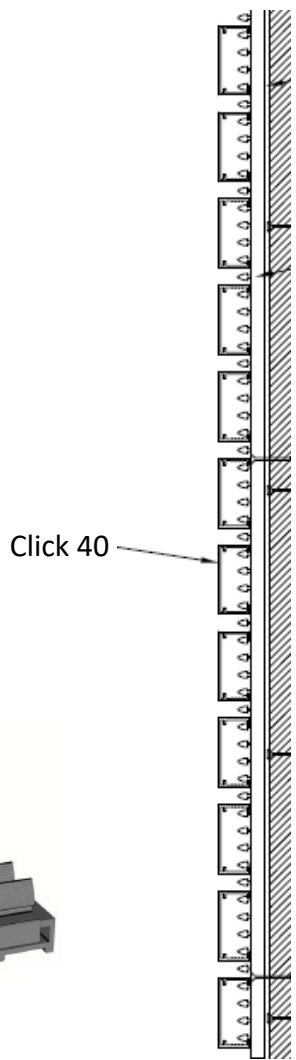

Universal 4+4

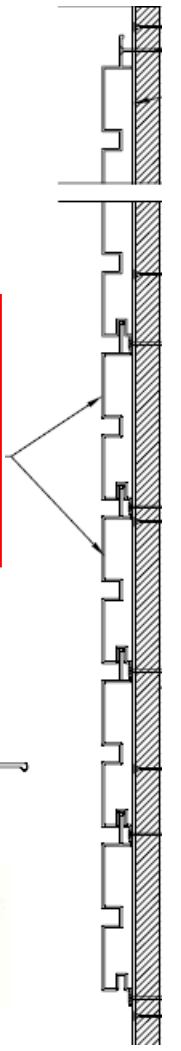

RAIL



ANGLE 30/30



CLICK 40

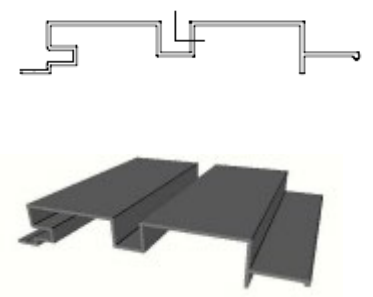

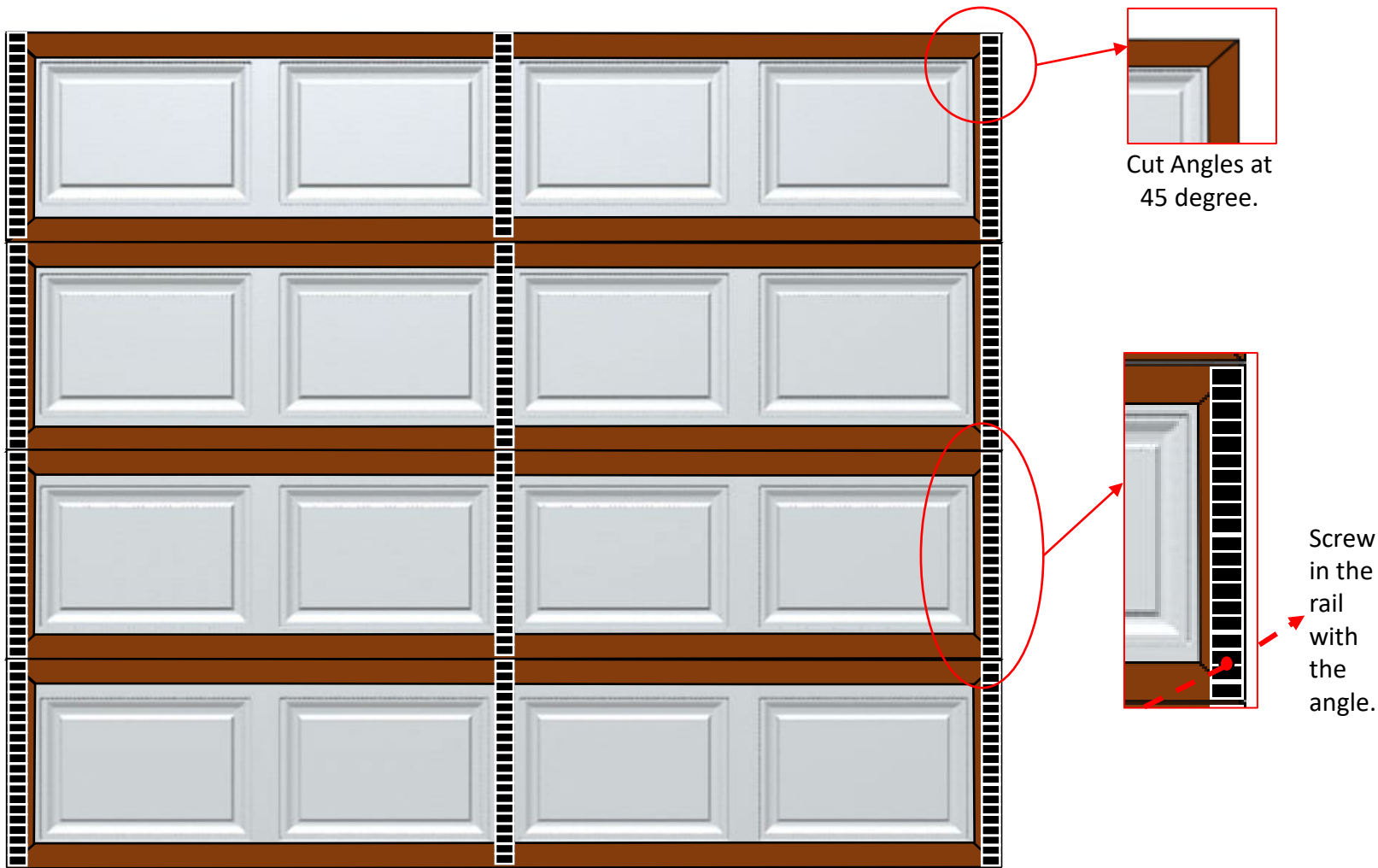

## GARAGE INSTALLATION



1

- Cut angles (30/30) at 45 degree and create a frame around each one of the garage door slats.



2

- Cut and Position the Rails within the slats (on top of the angles). Make sure to refer to our installation videos to properly cut the rails.



3

- Cut the profiles to size and click in the profiles. You can also fill up the gaps with the black u profiles. Alternatively, you can paint the garage door black before beginning the installation.



RAIL



ANGLE 30/30

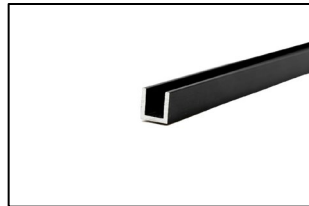

BLACK U10



CLICK 40

# UNIVERSAL ALUMINUM

# CLICK PROFILE SYSTEM

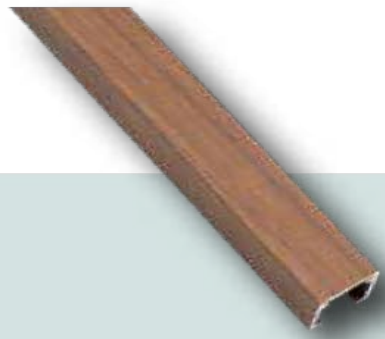

CLICK 20



CLICK 40

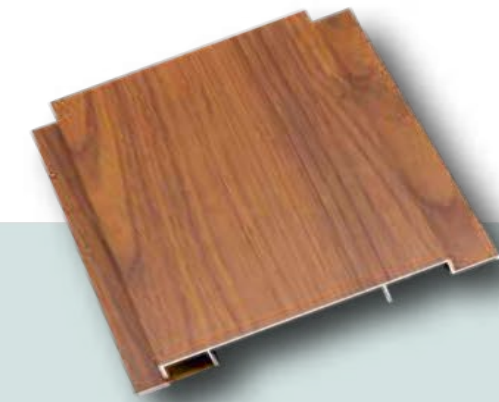

UNIVERSAL 140



CLICK 60



ANGLE 30/30, 40/40  
60/18 AND "L" SHAPE

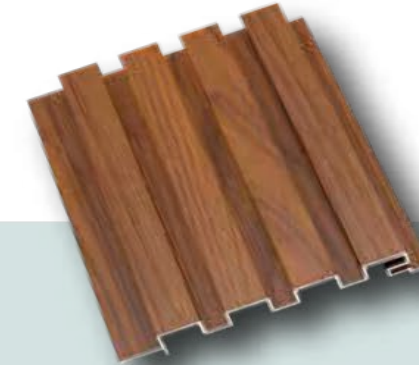

UNIVERSAL 2+2

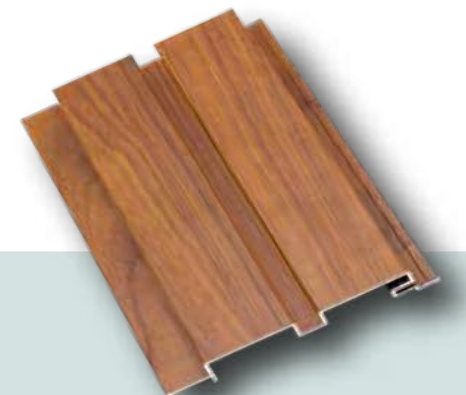

UNIVERSAL 4+4



ALEX + RAIL



RAIL



U10

## COLOR OPTIONS

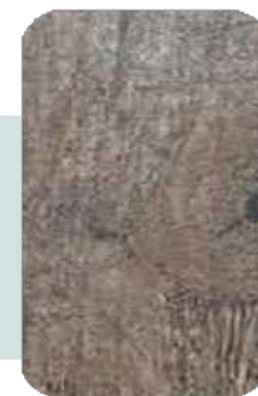

R4  
CLASSIC GRAY



1401  
ESPRESSO



1301  
PINE



1806  
DARK WALNUT



2301  
OAK

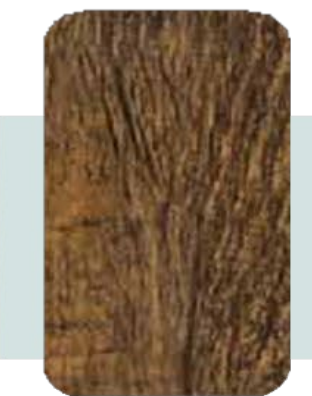

R3  
PROVINCIAL

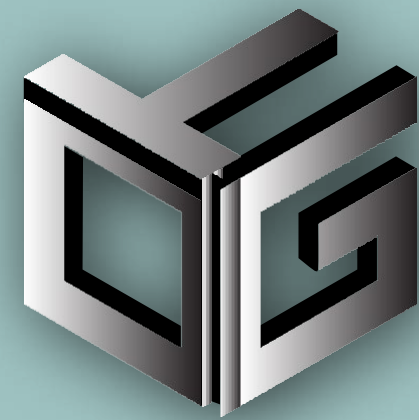

GTO  
ALUMINUM  
MANUFACTURING

## CONTACT US

---

 (702) 260-8829

 [Info@gtoaluminum.com](mailto:Info@gtoaluminum.com)

 4731 West Post Road Suite 130 | Las Vegas, NV 89118

[WWW.GTOALUMINUM.COM](http://WWW.GTOALUMINUM.COM)